

ELEKTRICKÉ LANOVÉ KLADKOSTROJE STACIONÁRNÍ
 TYP GS,GSF,GSM 0502-4/1
 NOSNOST 1000 AŽ 1600 kg.

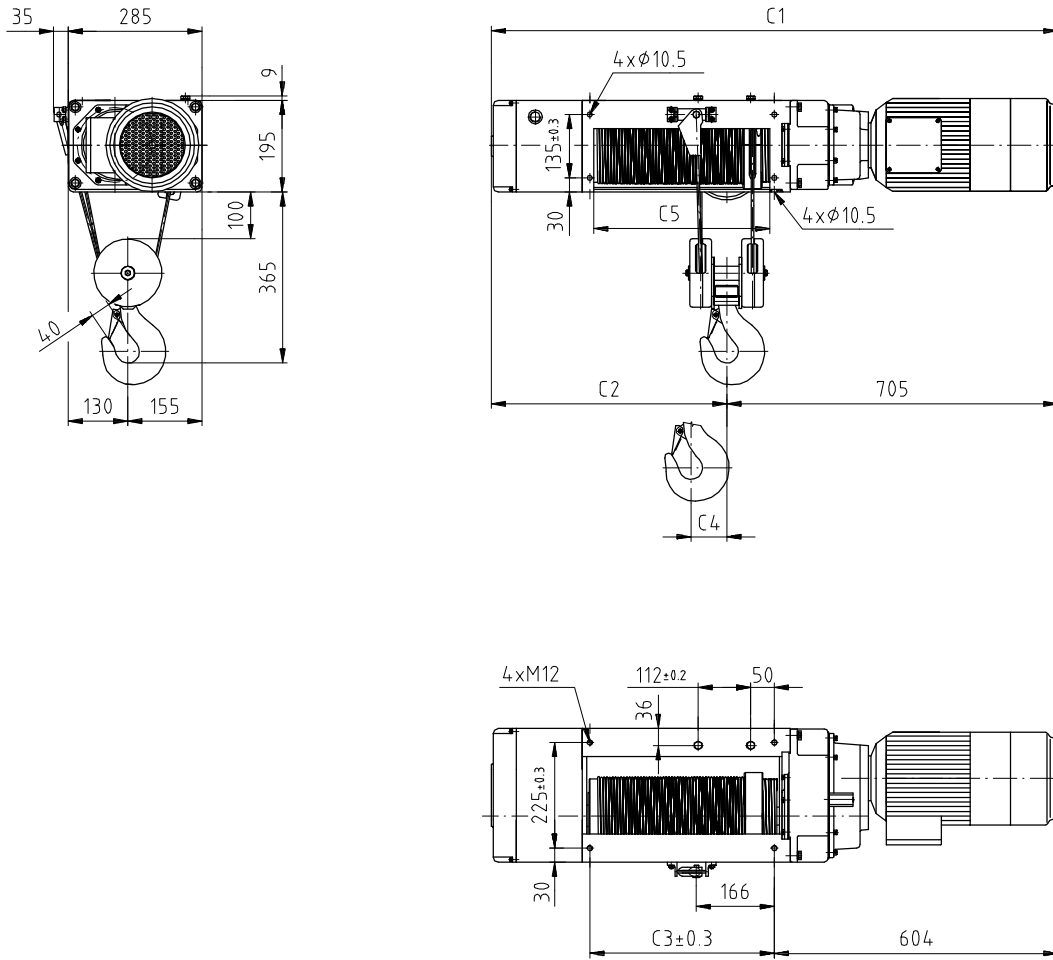

LANO ϕ 5mm									
TYP	6M	9M	12M	15M	18M	21M	24M	27M	30M
C1	1208	1358	1508	1658	1808	2108	2258	2408	2558
C2	503	653	803	953	1103	1403	1553	1703	1853
C3	393	543	693	843	993	1293	1443	1593	1743
C4	76	114	152	190	228	266	304	342	380
C5	375	525	675	825	975	1275	1425	1575	1725